

Beispielkombinationen

Example combinations

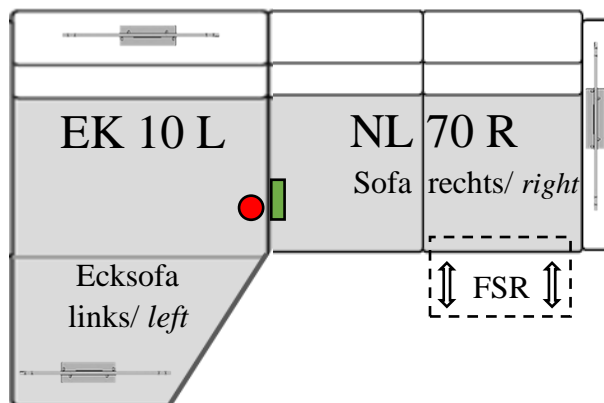

Elektrische Fußstützfunktion links oder rechts
Electric legrest function left or right

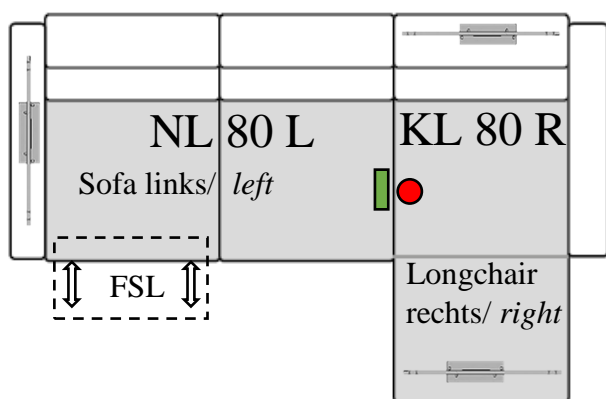
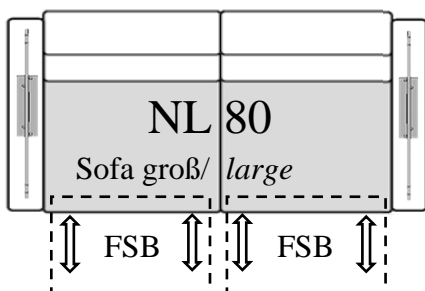

Elektrische Fußstützenfunktion beidseitig
Electric legrest function on both sides

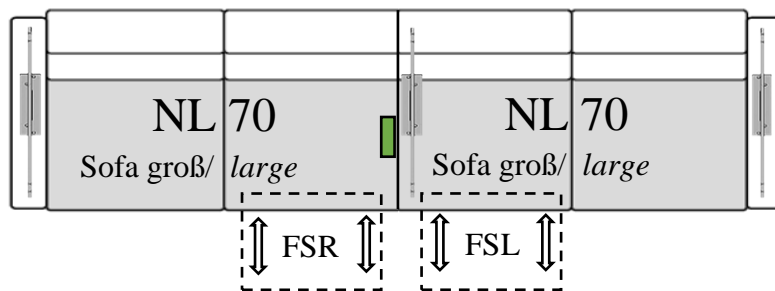

Elektrische Fußstützenfunktion auf zwei aneinander
gestellten Sofa Elemente möglich
*Electric legrest function possible on two sofa units
placed next to each other*

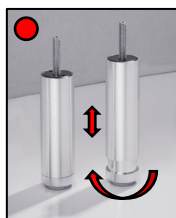

Höhenverstellbarer Stützfuß
Height adjustable support

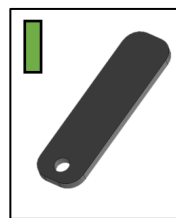

Kippsicherung
Anti-tilt device

Montagezubehör für Kufen

Assembly accessories for skids



Kufe F T9
Skid F T9



Kufe F 08
Skid F 08



Fußerhöhung F 08
leg elevation F 08



S3

M8 x 25 mm



U1

20 x 8 x 1,5 mm



S4

M8 x 45 mm



U1

20 x 8 x 1,5 mm

Optionales Montageset für Funktion pro Fußteil

Optional assembly accessories for function per legrest

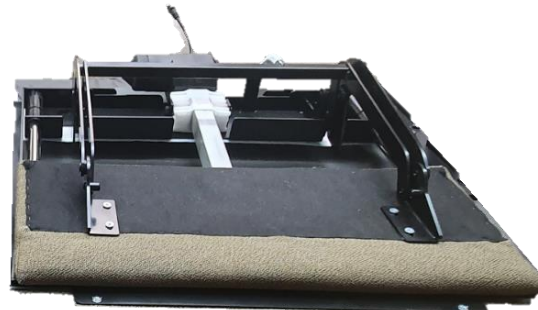

Motorchassis mit vormontierter Fußstützenfunktion

Engine - chassis with pre-assembled legrest function

4x



S6

M6 x 16 mm

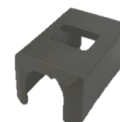

Netzteil inkl. Zuleitungskabel, Netzstecker – Kabel & Kabelsicherung

Power supply incl. supply cable, Mains plug - cable & cable fuse

Optionales Montageset pro beiliegende Ecksofa – Rückenlehnen

Optional assembly enclosed corner sofa - backrests

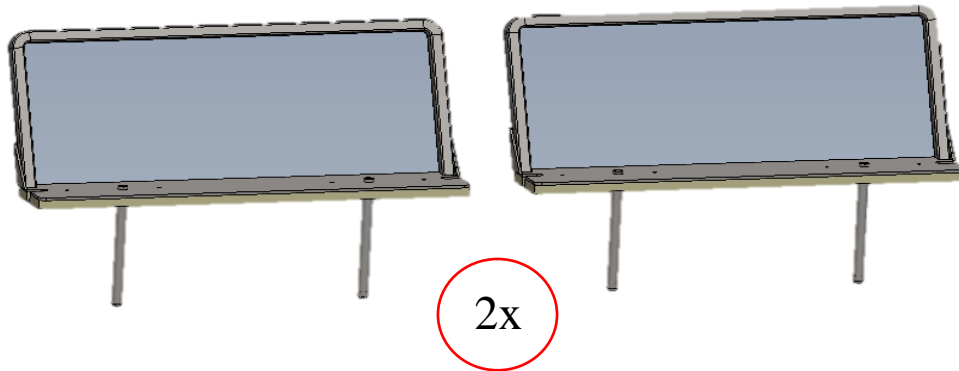

4x



30 x 10 x 2,5 mm

Beispiel Kufen - Montage bei Sofateilen

Example skids - assembly for sofa parts

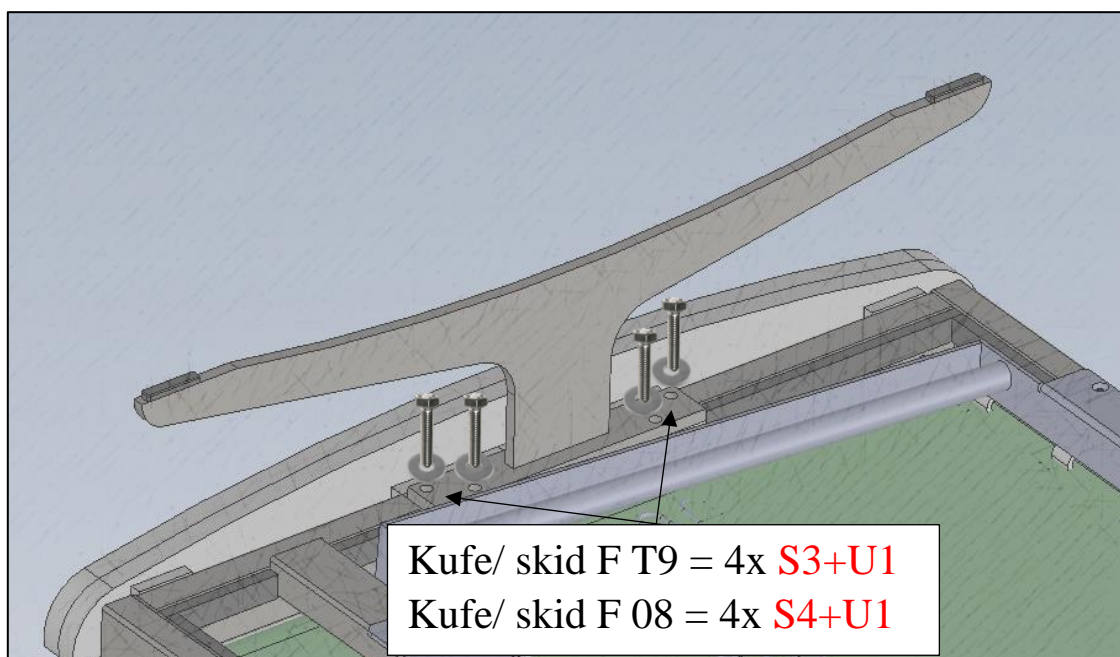

Beispiel Sockel Kufe - Montage bei Sofa Elemente

Example base skid - assembly with sofa units

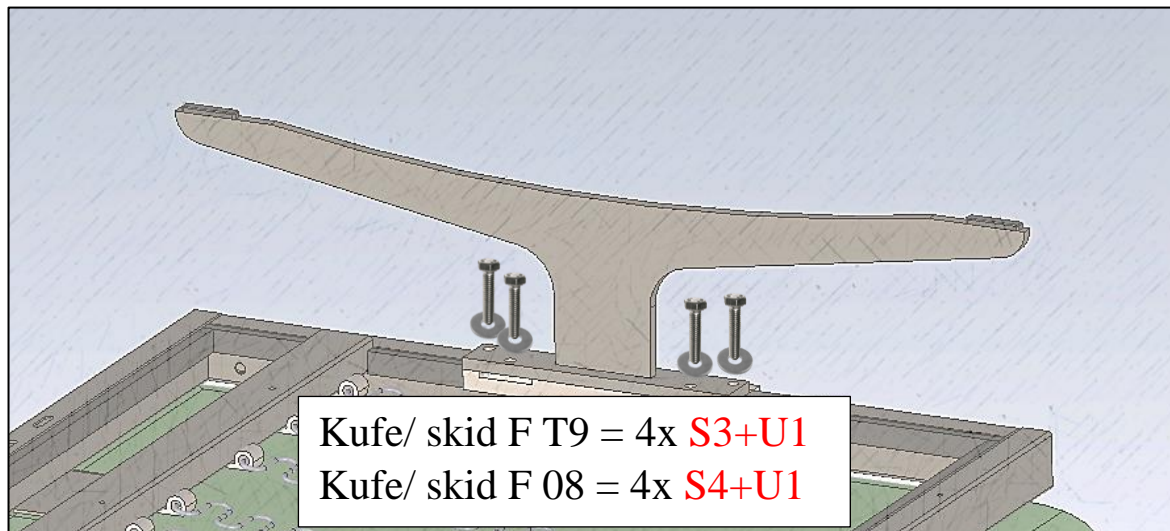

Achtung: Genauere Hinweise der Sockelkufe - Montage bei unten stehender Anweisung der Kippsicherung entnehmen!

Attention: For more detailed information on the installation of the base skid, see the instructions below. see the instructions for the anti-tilt device below!

Beispiel Kufen Montage Longchair und Ecksofas

Example skid assembly long chair and corner sofas

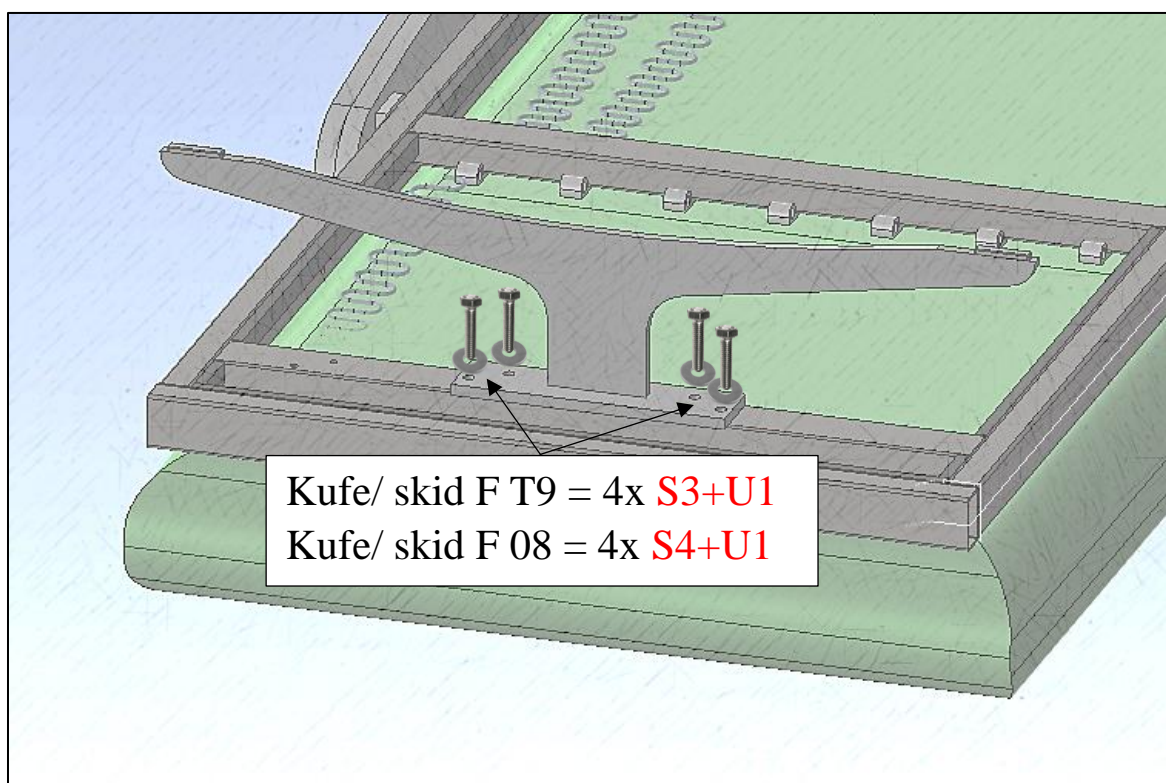

Beispiel Montage der Rückenlehnen des Ecksofas

Example of assembling the backrests to the corner sofa frame

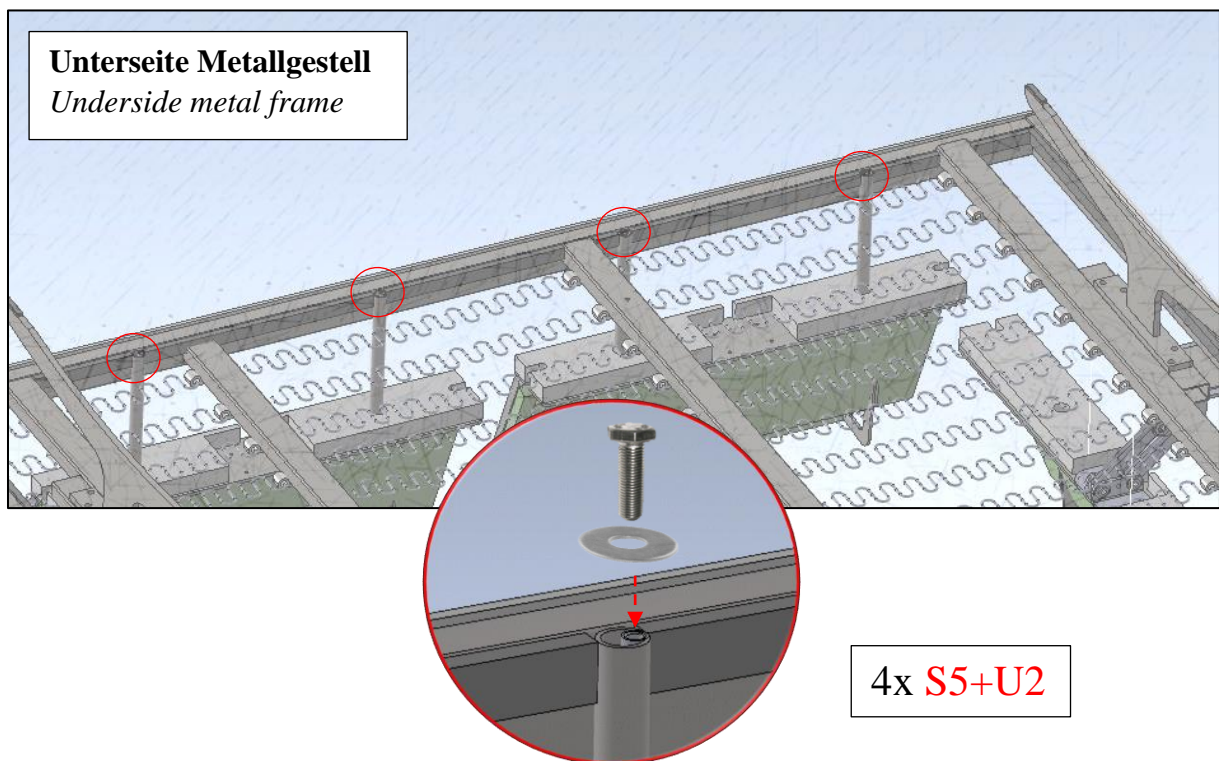
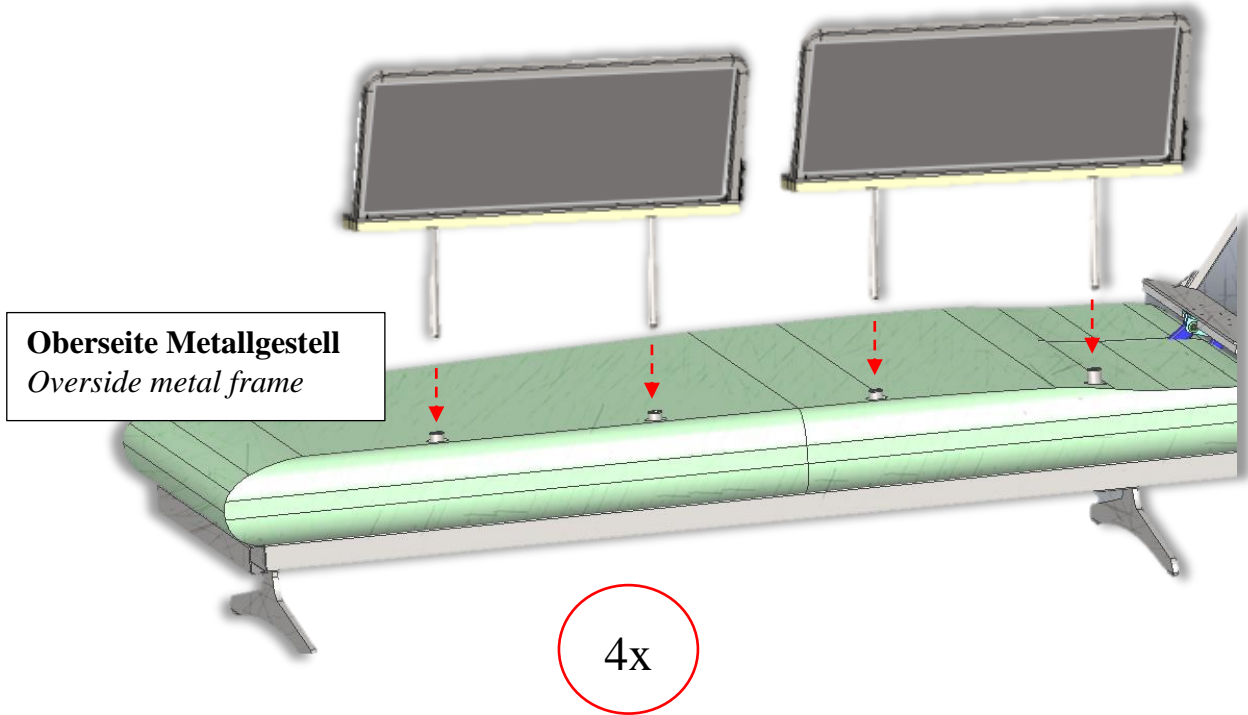

Beispiel Montage Stützfuß bei Longchair & Eck - Sofas

Example assembly of support leg for long chair & corner sofas

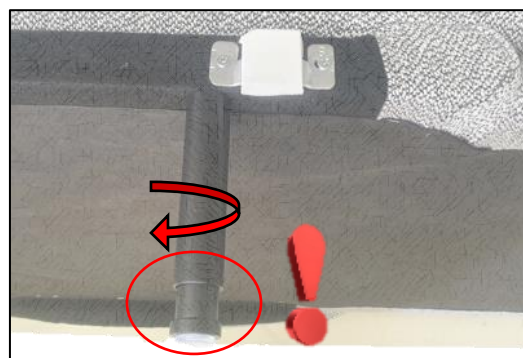
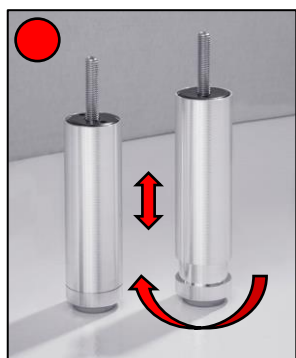

Beispiel der Kippsicherung bei Longchair & Eck – Zusammenstellungen

Example of the anti-tilt device for long chair & corner sofas combinations

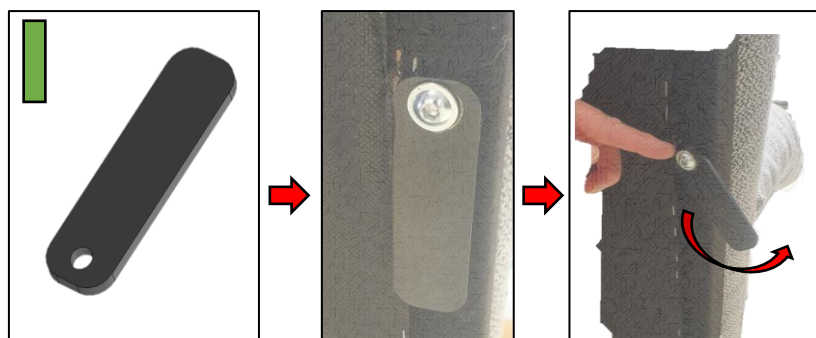

Beispiel der Kippsicherung bei Sofa – Zusammenstellungen mit Sockelkufe

Example of anti-tilt device for sofa compositions with skid base

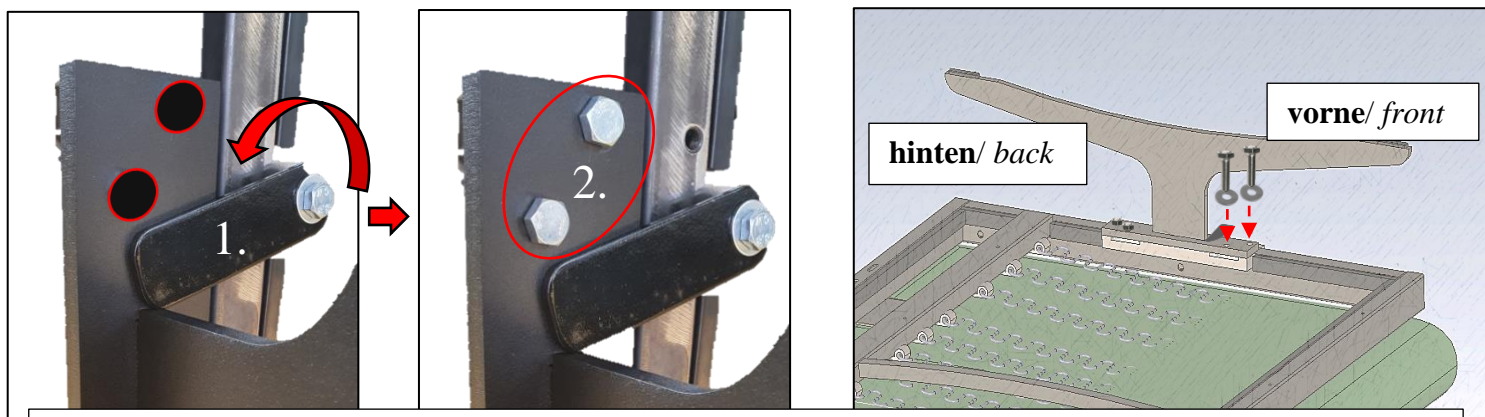

Wichtig: Kippsicherung erst auf Kufe drehen, danach die 2 vorderen Montageschrauben montieren!
 Important: Screw the anti-tilt device onto the skid, then assemble the 2 front assembly screws!

Beispiel optionaler Aufbau Motorchassis und Montage mit Sitzpolstergestell

Example of optional motor chassis and assembly with seat frame



Achtung:

Motorsteuerungs - Kabel im Sitzgestell vormontiert

Attention:

Engine control cable in seat frame pre-assembled



2 Personen
2 persons

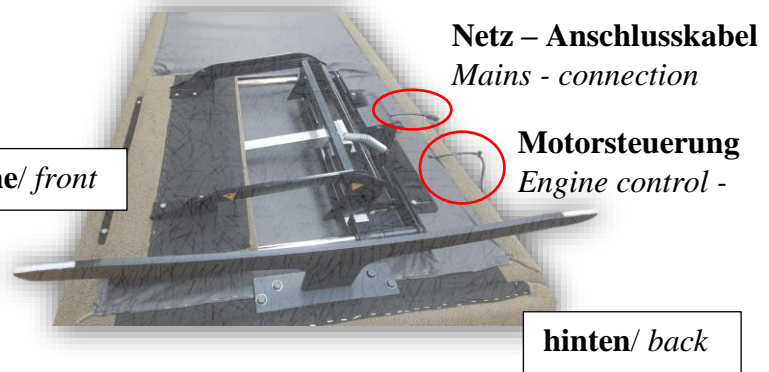
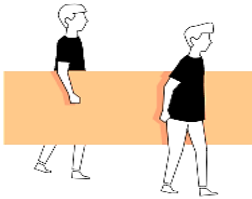

Netz - Anschlusskabel
Mains - connection

Motorsteuerung
Engine control -

Befestigung der Mechanik am Sitzgestell
Fixing the mechanism to the seat frame

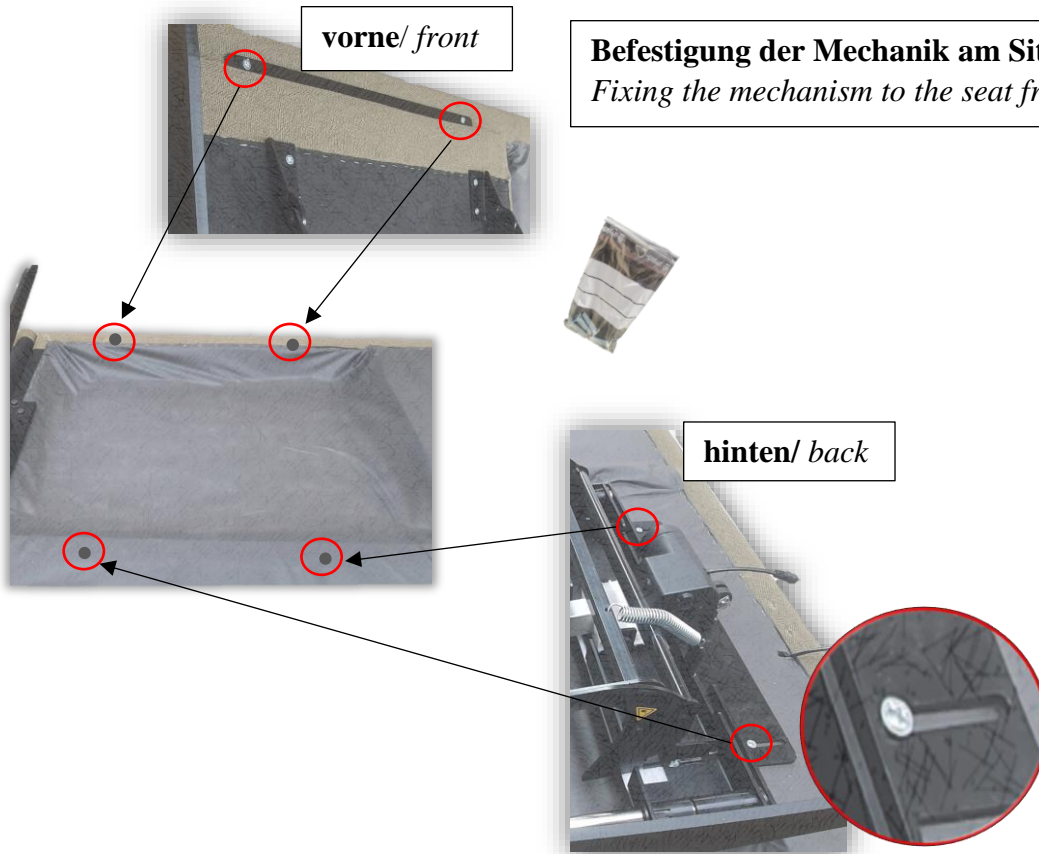

Verbindung Motor – Elektronik

Connection motor - electronics





Motor Gehäuse
Engine casing

Netz – Anschluss mit Trafo - Zuleitung verbinden
Connect the mains connection to the transformer supply line

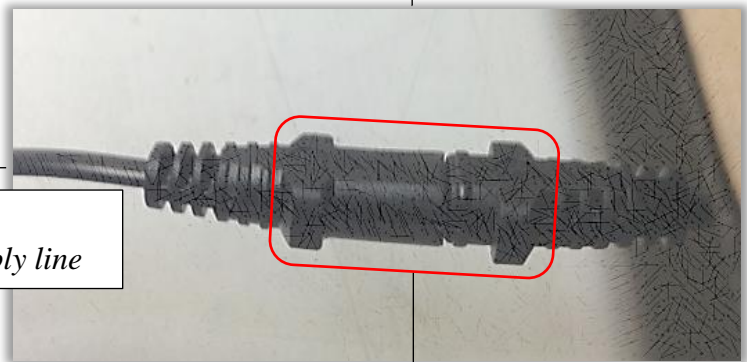

Trafo - Zuleitung
Transformer - supply line

Kabelsicherung anbringen!
Attach cable fuse!

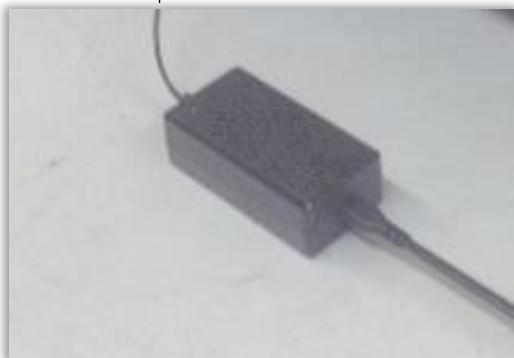

Trafo - Zuleitung mit Netzstecker Kabel verbinden
Connect transformer - supply line with mains plug - cable

